

# B\_SUITE

HIGHLY TECHNOLOGICAL,  
ADVANCED SOFTWARE SOLUTIONS



# A SINGLE, INTEGRATED SOFTWARE SOLUTION



A single platform to manage all machine processes.

**B\_SOLID**



**B\_EDGE**

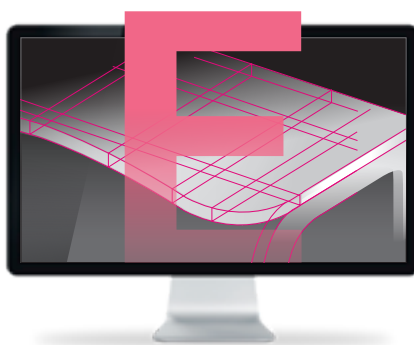

**B\_NEST**



## THE MARKET EXPECTS

**user-friendly software solutions** for woodworking and advanced material processing machines that can be used by all operators without the need for special IT skills.

## BIESSE MEETS

these requirements by developing software solutions around our customers' day-to-day operations, with user-friendly and intuitive interfaces. **B\_SUITE** is a complete suite of advanced software tools, giving users access to cutting edge technology. If software is the only limitation to a machine's capabilities, then bSuite offers endless possibilities.

# HIGH-TECH BECOMES ACCESSIBLE AND INTUITIVE



**B\_SOLID IS A 3D CAD CAM SOFTWARE PROGRAM THAT SUPPORTS THE PERFORMANCE OF ANY MACHINING OPERATION THANKS TO VERTICAL MODULES DESIGNED FOR SPECIFIC MANUFACTURING PROCESSES.**

- Planning in just a few clicks.
- Simulating machining operations to visualise the piece ahead of manufacturing and have some guidance for the planning phase.
- Virtual prototyping of the piece to avoid collisions and ensure optimal machine equipment.
- Machining operation simulation with a calculation of the execution time.



# PLANNING IN JUST A FEW CLICKS

Importing or drawing any type of project (2D and 3D),  
from the easiest to the most complex, thanks to a unique  
design system.



Thanks to the integration of a new learning system, the software enables users to access sophisticated functionalities. The user only needs to set the dimensions and then - with a simple click - can visualise the product to be processed on a screen, together with all the operations needed to manufacture it.

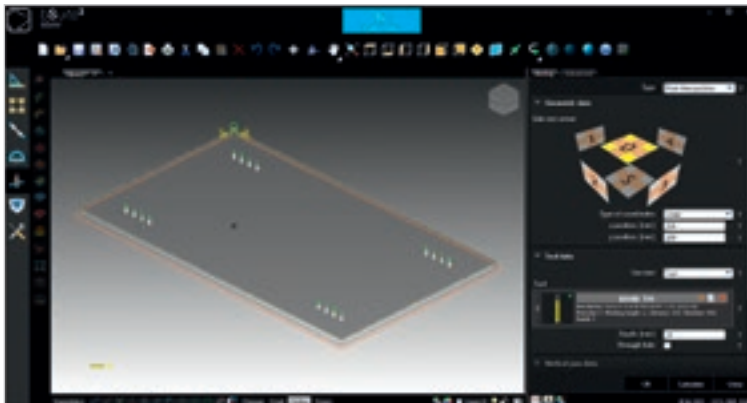

Parametric software  
Adapts automatically to the various  
piece dimensions.

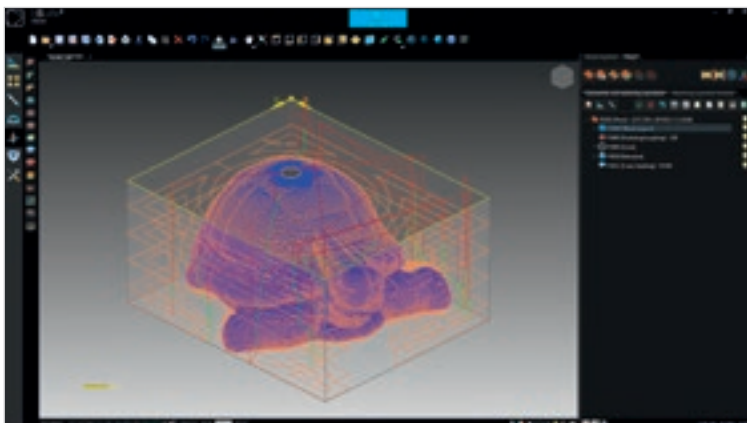

Machining of complex 3D shapes  
with user-friendly functions.

# SIMULATING MACHINING OPERATIONS TO VISUALISE THE COMPONENT PRIOR TO MANUFACTURING

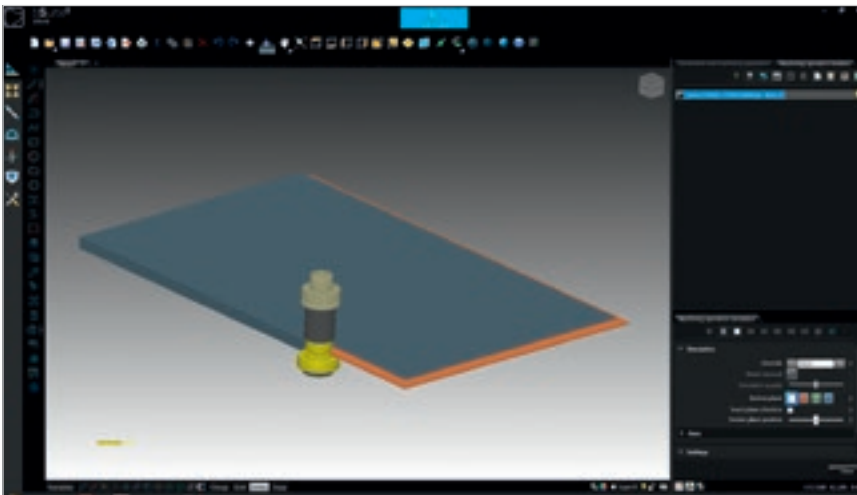

B\_SOLID enables the user to verify the project through rapid and effective 3D simulation that supports:

- ✓ verification of the accuracy of the tool path;
- ✓ immediate, intuitive check of the machining operations and the effect of the tools on the piece;
- ✓ modifying and checking the project before machining.

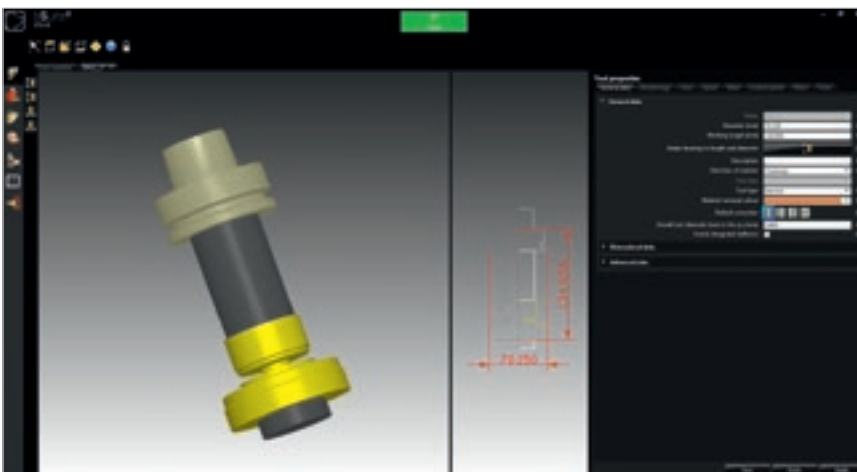

The tool management module offers the possibility to create and modify milling cutters, blades and boring bits to suit the customer's needs.

# VIRTUAL PROTOTYPING OF THE COMPONENT

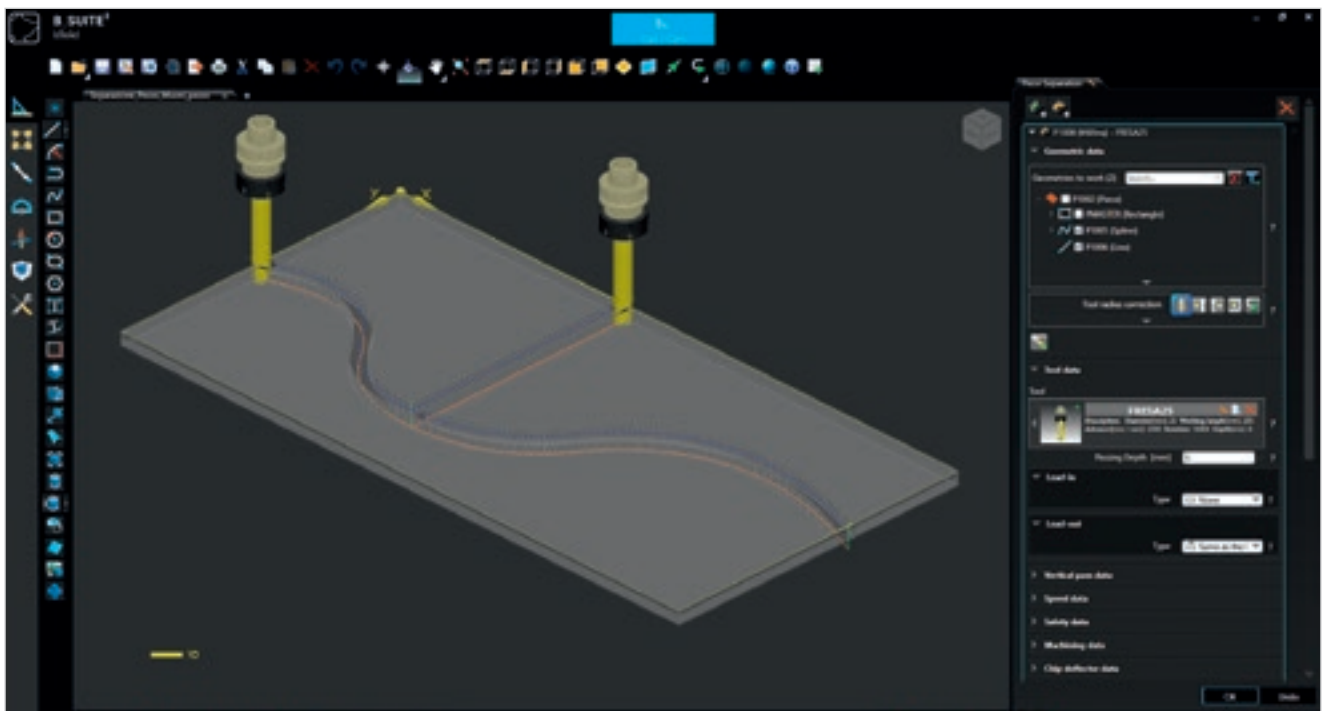

B\_SOLID allows the piece programmed in the CAD/CAM area to be seen directly on the machine work table, so all piece and sub-piece movements can be programmed in that environment.



Thanks to the collision check, any interference between machine parts can be verified directly from the office, so potential errors can be prevented or corrected



# CALCULATION OF THE TIME NEEDED TO CARRY OUT ALL THE MACHINING OPERATIONS

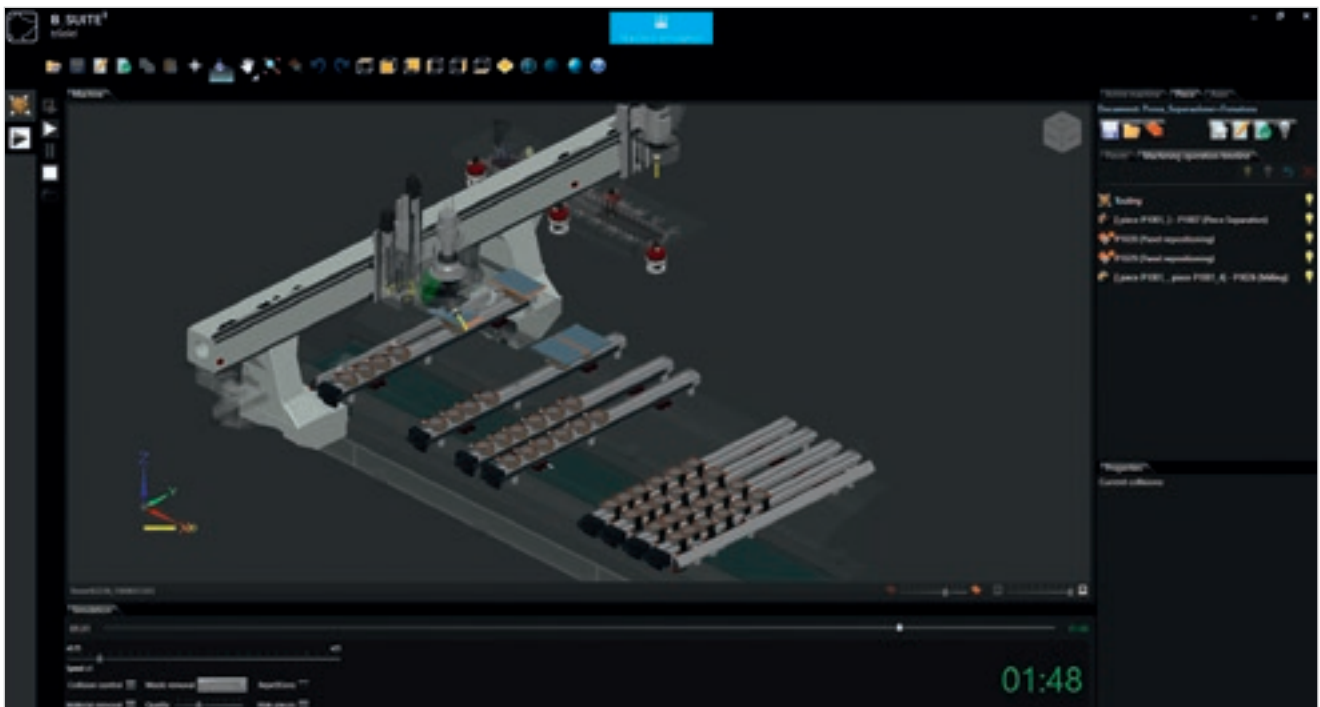

Simulation is not only handy when it comes to checking or preventing collisions; it also enables a calculation of the time needed to carry out all the machining operations, thereby facilitating the factory logistics system.

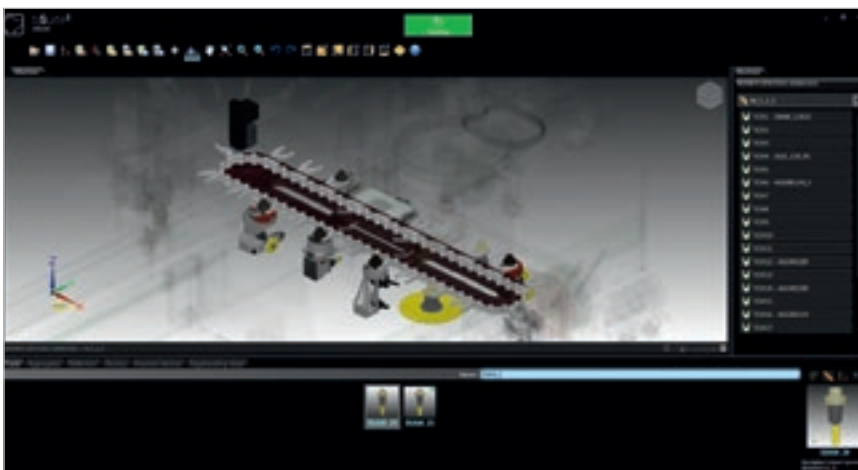

The tool magazine and spindles can be tooled with a simple drag and drop.

# SIMPLIFYING EDGEBANDING PROGRAMMING



**B\_EDGE IS AN ADDITIONAL MODULE INTEGRATED IN B\_SUITE. MAKING FULL USE OF THE CAPACITIES OF THE SUITE, B\_EDGE SIMPLIFIES THE PROGRAMMING OF THE EDGEBANDING PROCESS.**

- Automatic generation of the edgbanding operation sequence.
- Easy to understand and operate.
- Simplified management of edgbanding strips and edgbanding devices.

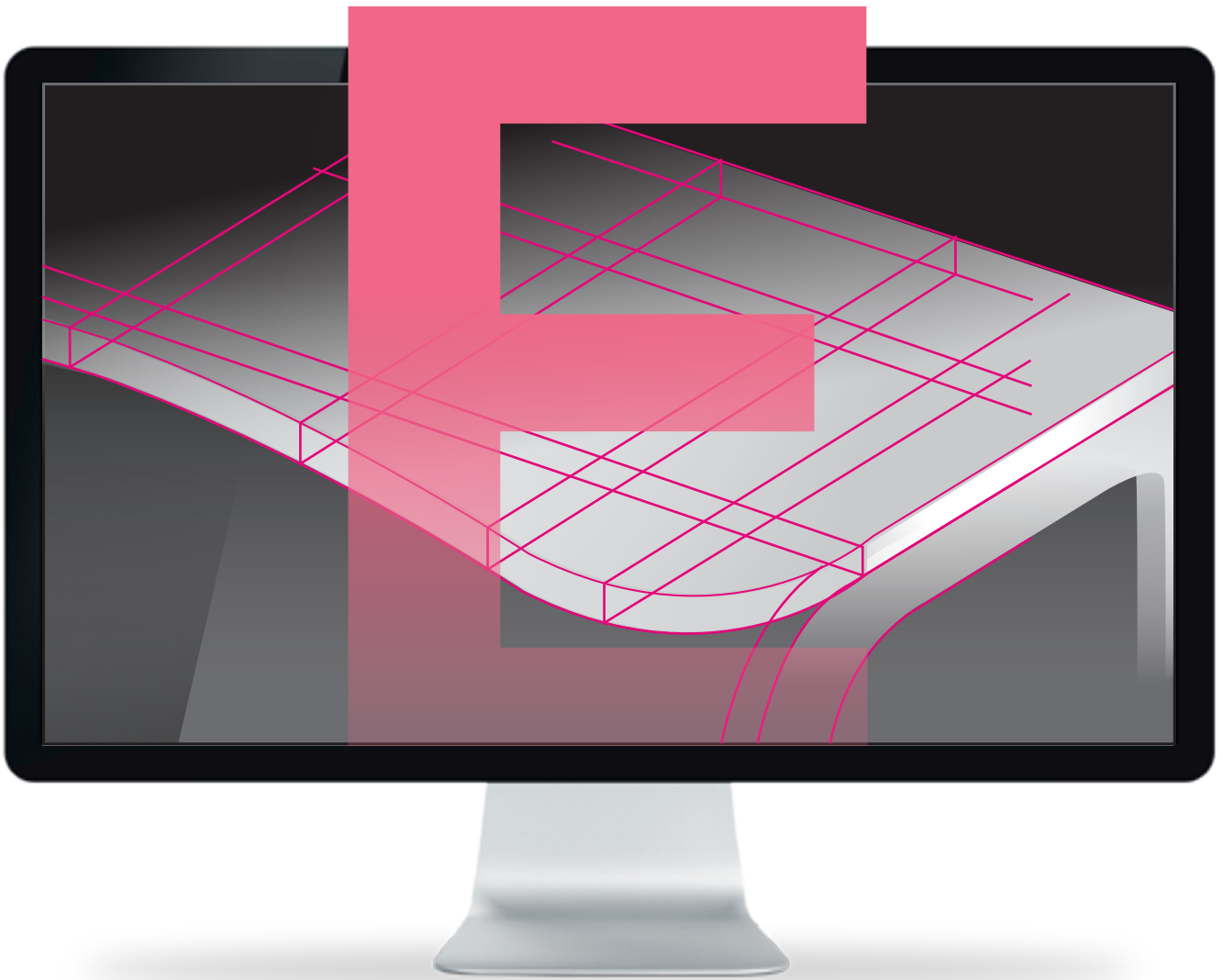

# AUTOMATIC EDGEBANDING OPERATION SEQUENCE

B\_EDGE reduces design times, allowing the edgebanding operation to be programmed in just a few steps.

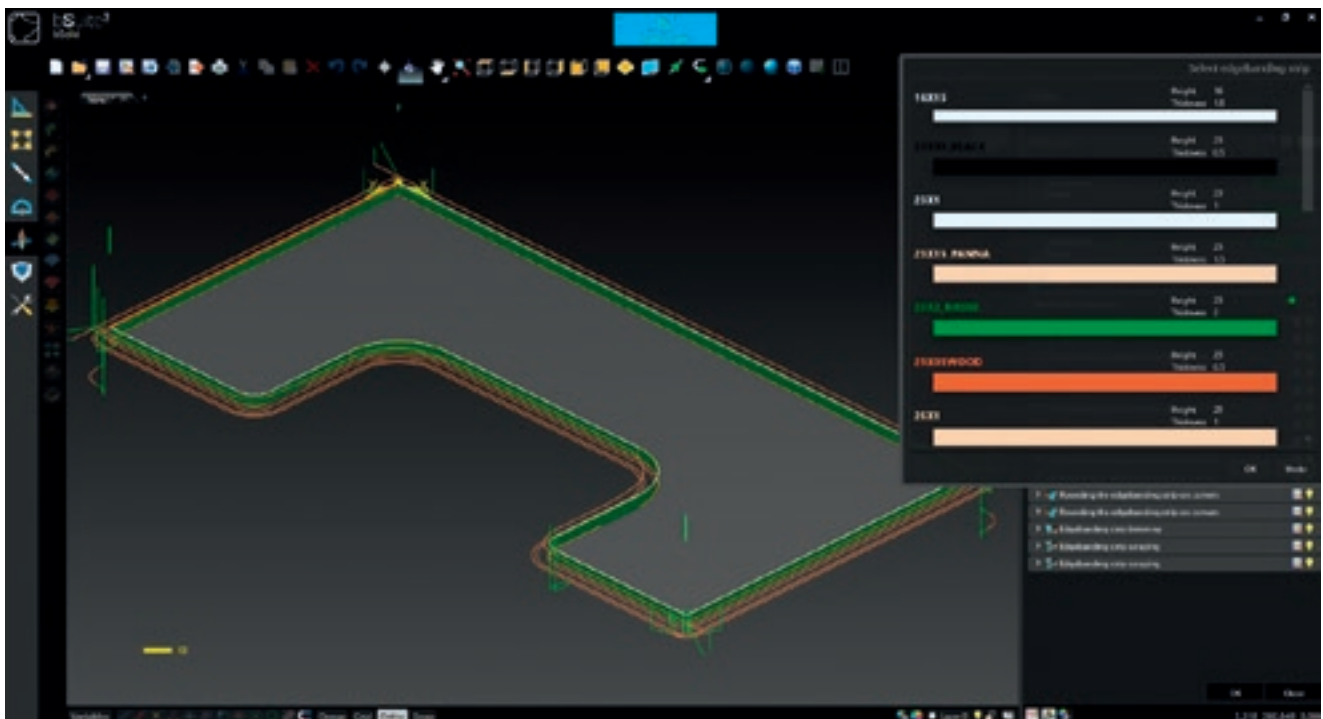

Automatic generation of the edgebanding operation sequence (pre-edgebanding, edgebanding, post-edgebanding).

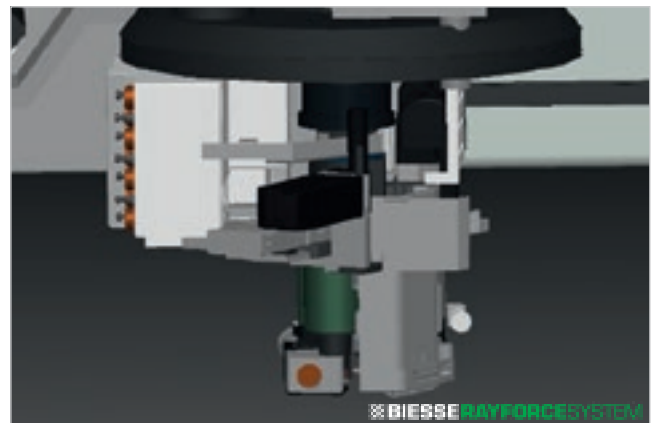
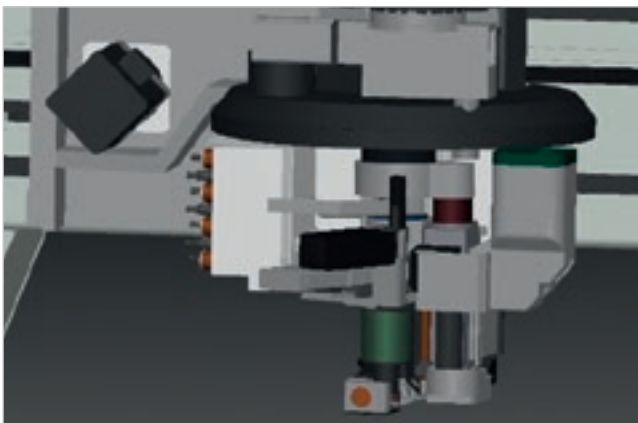

Simulation of the machining operations and the various edgebanding devices (glue or RayForce System).



Customised configurations for simple management of the edgbanding parameters.

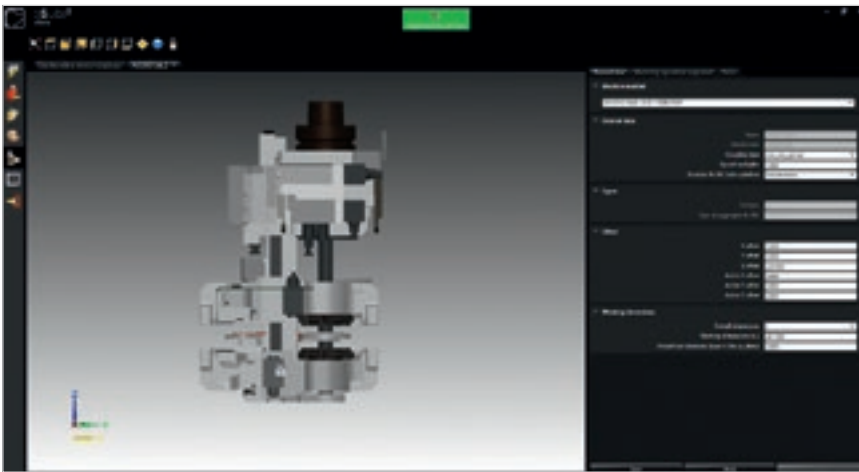
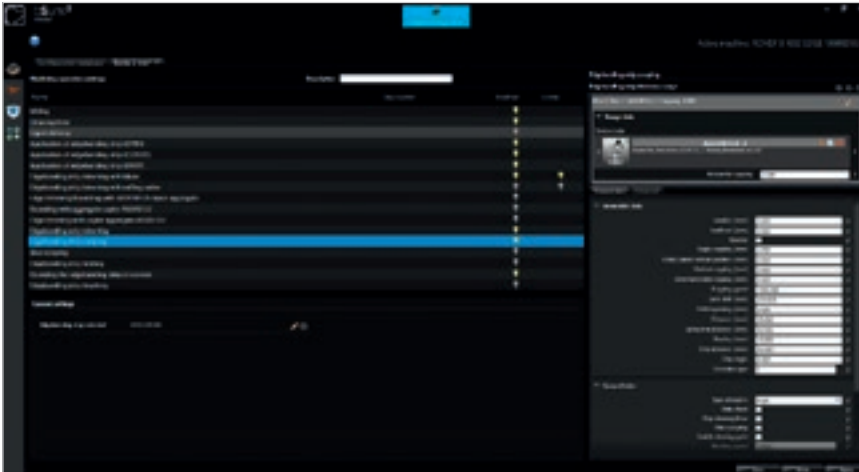

Simplified management of the post-edgbanding devices.

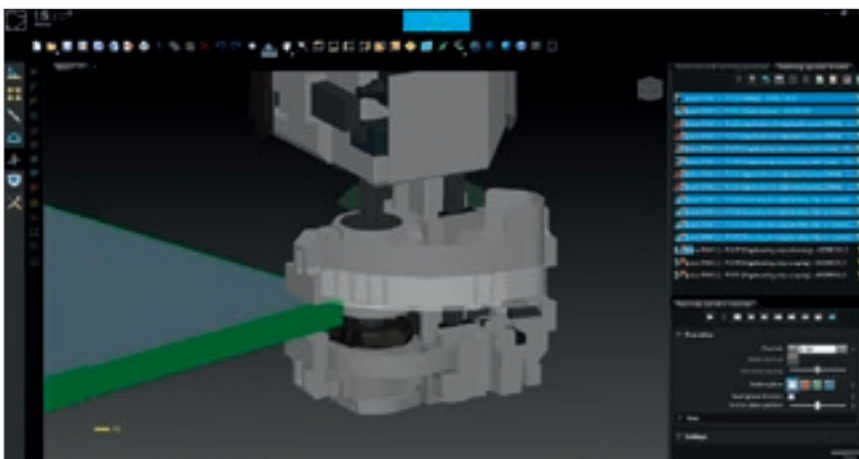

# REDUCED TIME AND WASTE



**B\_NEST IS THE B\_SUITE PLUGIN SPECIFICALLY FOR NESTING OPERATIONS. IT ALLOWS YOU TO ORGANISE YOUR NESTING PROJECTS IN A SIMPLE WAY, REDUCING THE MATERIAL WASTE AND MACHINING TIMES.**

- ✔ Flexibility with reduced production times and costs.
- ✔ Optimisation for every type of product.
- ✔ Management of articles, sheets and labels.
- ✔ Integration with company software.



# FLEXIBILITY WITH REDUCED TIMES AND PRODUCTION COSTS

B\_NEST identifies the most efficient production layout and sequence for rectangular or shaped elements, thanks to the various algorithms in the software.

Thanks to B\_NEST, production times and costs can be optimised because all the necessary pieces are produced in one single machine step, with the minimum calculated waste.

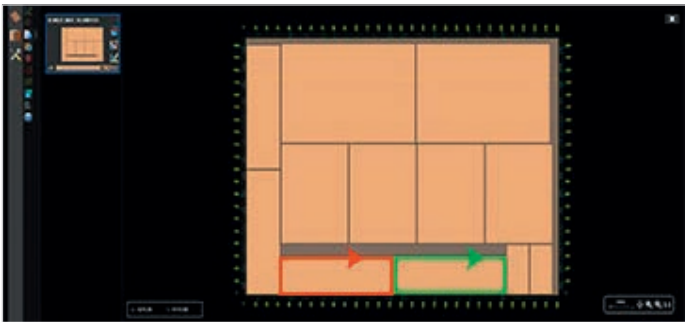

**Cutting optimizer:** all the pieces are machined with the mill making a complete movement around them.

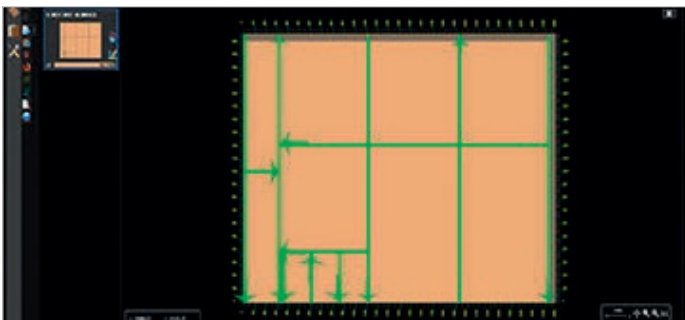

**Guillotine cut:** algorithm that positions the pieces in the same way that a panel saw would do. Where possible, milling operations are longitudinal or transverse in relation to the sheet.

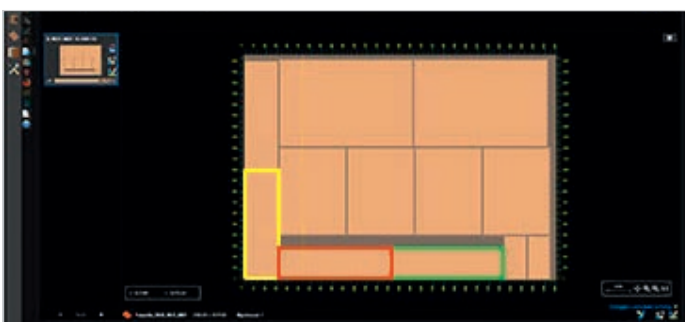

**Common cut algorithm:** this algorithm positions the pieces so that a single tool movement can be made along the shared piece sections.

A choice of nesting algorithms means that the best compromise between waste, finish and execution time can be defined.



# OPTIMISATION FOR EVERY TYPE OF PRODUCT

Various calculation options allow B\_NEST to generate specific nesting layouts for the customer's type of production.

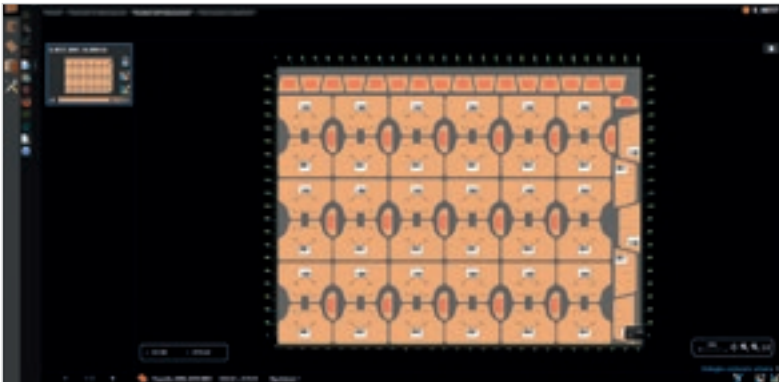

**Free-shape nesting:** guarantees the minimum waste for pieces of any shape.

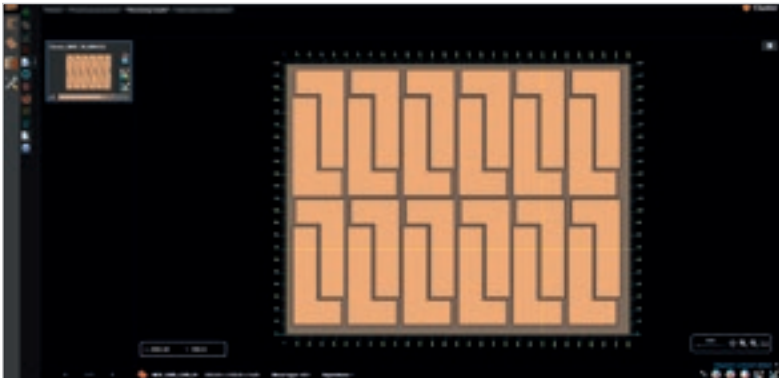

**Cluster:** the cluster function combines the pieces in sub-groups to reduce waste.

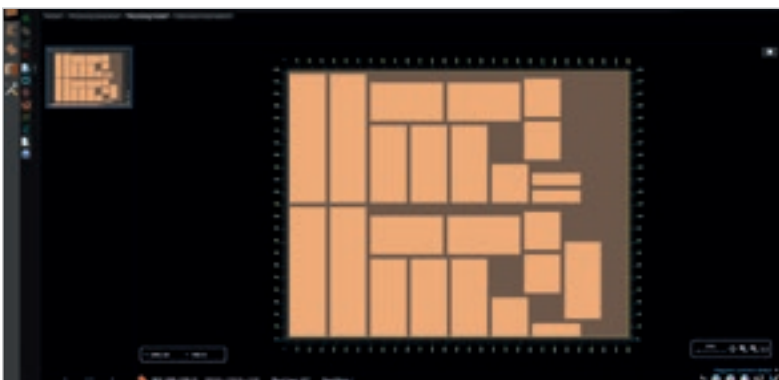

**Multi-head nesting:** a nesting algorithm for optimising machining operations with two working units operating simultaneously.

# MANAGEMENT OF ARTICLES, SHEETS AND LABELS

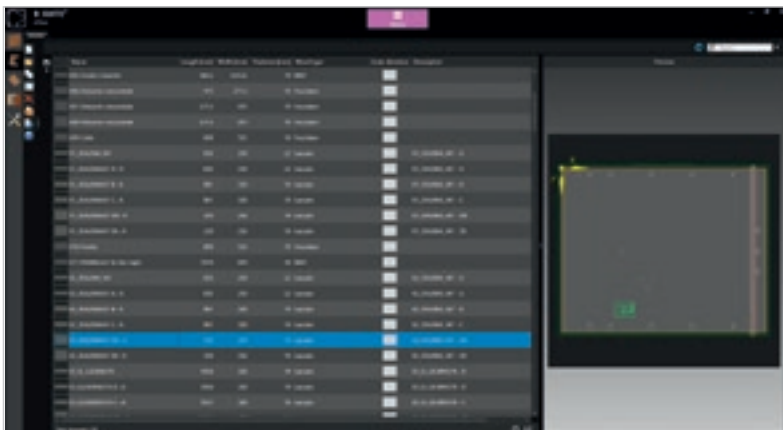

**Managing articles:** the articles are shown on the screen, making it easier to select them. They can also be arranged in folders so they're easier to manage.

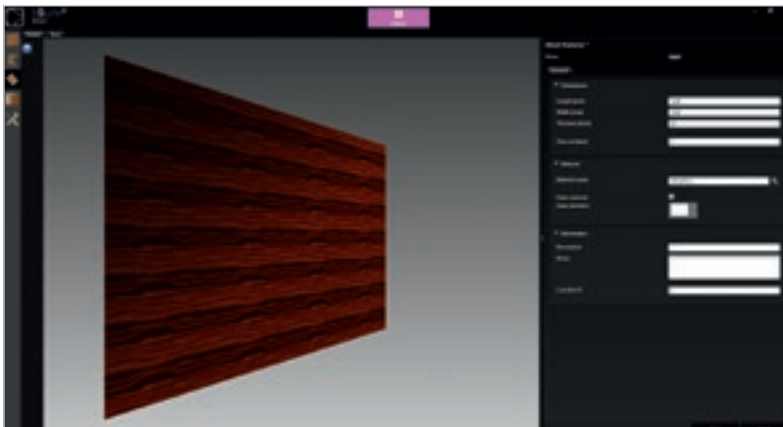

**Managing sheets.**



**Labels:** B\_NEST is used to create and modify the labelling layout, adding information obtained from the customer's database software. B\_NEST can manage both bar codes and QR codes.

## B\_NEST evolves to meet the needs of even the most demanding customer.

As the market moves forward, B\_NEST adds increasingly advanced functions to keep up with the times.

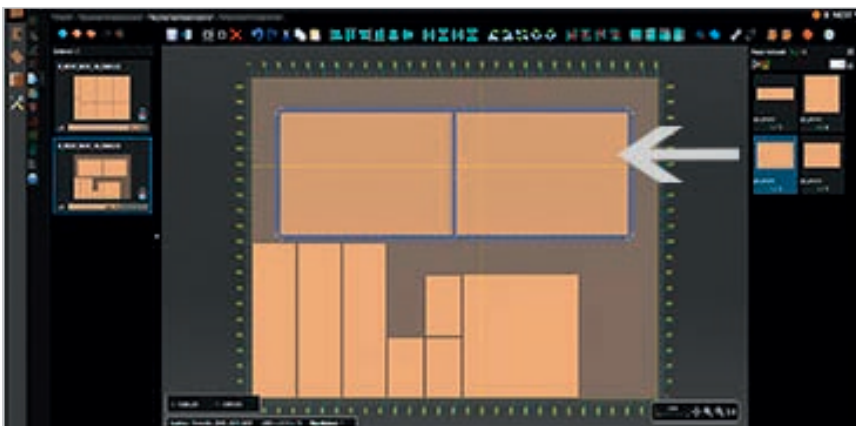

**Manual results editor (opt):** a simple, user-friendly environment for modifying the nesting results. The editor has tools that simplify the manual filling of the sheets.



**Grain matching (opt):** allows pieces to be nested in blocks whilst maintaining their relative positions; the results are of a higher quality, for instance maintaining grain continuity.

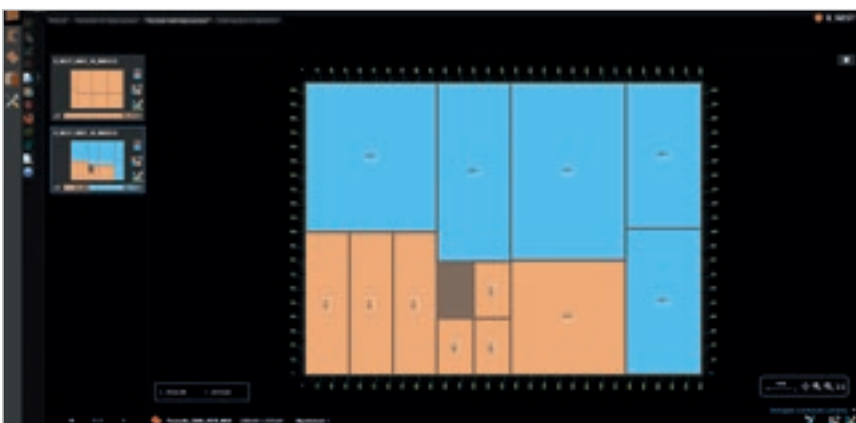

**Rest management (opt):** automatic management of material considered reusable on the basis of criteria set by the user.

# CUSTOMER CARE IS WHO WE ARE

**SERVICES** is a new experience for our customers, to offer not just excellent technology but the added value of an increasingly direct connection with the company, the professionals who work there and the experience they embody.



## **ADVANCED DIAGNOSTICS**

Digital channels for remote interaction online 24/7. Always ready to intervene on-site seven days a week.



## **A WORLDWIDE NETWORK**

39 branch offices, over 300 certified agents, retailers in 120 countries, and spare parts warehouses in America, Europe and the Far East.



## **SPARE PARTS AVAILABLE IMMEDIATELY**

Identification, shipping and delivery of spare parts.



## **EVOLVED TRAINING OPPORTUNITIES**

Lots of on-site, online and classroom training modules for personalised growth.



## **VALUABLE SERVICES**

A wide range of services and software packages to help our customers achieve continuous improvements in performance.

## AN EXCELLENT LEVEL OF SERVICE

**+550**

HIGHLY SPECIALISED  
TECHNICIANS AROUND  
THE WORLD, READY TO HELP  
CUSTOMERS

**90%**

OF MACHINE DOWN CASES  
WITH RESPONSE TIMES  
UNDER 1 HOUR

**+100**

EXPERTS IN DIRECT  
CONTACT THROUGH  
REMOTE CONNECTIONS  
AND TELESERVICE

**92%**

OF SPARE PARTS ORDERS  
FOR MACHINE DOWNTIME  
PROCESSED WITHIN 24  
HOURS

**+50.000**

ITEMS IN STOCK IN THE  
SPARE PARTS WAREHOUSES

**+5.000**

PREVENTIVE MAINTENANCE  
VISITS

**80%**

OF SUPPORT REQUESTS  
SOLVED ONLINE

**96%**

OF SPARE PARTS ORDERS  
DELIVERED IN FULL ON TIME

**88%**

OF CASES SOLVED WITH  
THE FIRST ON-SITE VISIT

# MADE WITH BIESSE

## MCM OF CANTÙ

"Biesse has always been a reference point for us;" states Mirco Molteni "we have always worked extremely closely with them so that they could be very familiar with end user requirements, and be almost like another tool for us. Now we have become self-sufficient even for complex processes. We manufacture custom pieces and, thanks to bSolid's user-friendliness, we can turn them around within very short time lines. It is so convenient that we are gradually moving more and more processes - even simple ones - on the centre equipped with bSolid. We can complete a drawing's development process and move on to production within one hour, which is something we only used to be able to do in a day. bSolid is intuitive, parametric, more powerful and versatile, particularly for surfaces.

With bSolid all you need to do is set the dimensions, in a quick and easy way, follow the instructions and then the work piece is visualised on the screen, together with all operations needed to process it. Once the drawing in the system, bSolid automatically programmes all necessary processing operations, down to specifying which tool to use. And if I have designed a complex piece and realise that I have made a mistake, I don't have to start again from scratch: all I need to do is insert the necessary changes and... job done! The new Biesse software goes through a verification stage and suggests a 3-D simulation, highlighting any problems, of any type, also thanks to the anti-collision system. In short, an operator can programme the component to be manufactured in just a few, easy

steps, verifying tool paths, identifying the most suitable tool and seeing how tool changes will be executed, through to the end result. At this point, he/she can start real production with no risks! Working together with Biesse to make sure that this software program takes into account the requirements and way of thinking of us furniture manufacturers was a fantastic opportunity", stresses Mr. Molteni. "I think they have managed to understand our needs and have created a tool that is very sophisticated and yet easy to use at the same time, that manages to put even the most conservative joiners at ease...".

*Source: XYLON September-October 2013 MCM, a Biesse customer since 1992, is one of the main manufacturers of custom, high-end furniture*



Founded in Italy,  
international native.

We are an international company that manufactures integrated lines and machines to process wood, glass, stone, plastic and composite materials and what will come next.

Thanks to our rooted competence nurtured by an ever-growing worldwide network, we support your business evolution – empowering your imagination.

Master of materials, since 1969.

We simplify your  
manufacturing  
process to make  
the potential of  
any material  
shine.



Join the  
Biesse world.

[biesse.com](https://www.biesse.com)



